

## ELEGANCE

The **Elégance** executive desks stand out by the subtle combination of the stylish crossed legs and the worktops, an elegant and pure design enhanced by metallic edges with graphite finish. **Elégance** desks are available in straight single version or with a built-in return storage unit to create imposing furniture suitable for all executive spaces.



## CHARACTERISTICS



— Tops and legs MFC finishes

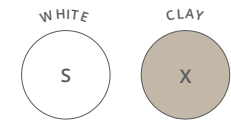

— Interior of storage unit finishes

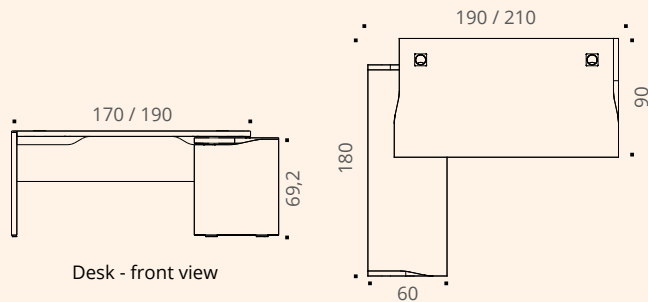

Desk - front view

Desk - top view

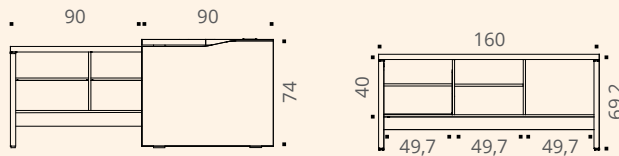

Desk - side view

Storage unit

## ELEGANCE



EXECUTIVE DESKS

### Electrification

2 Ø 80 mm cable ports with a square chrome cover.

### Storage unit

Return storage unit body made of 38 mm thick Nitech® melamine-coated panels. Interior fittings available in 2 plain finishes. Not reversible.

### Top

38 mm Nitech® honeycomb melamine-coated panels. 2 mm thick shock-proof ABS edging.

### Edges

Acrylic edges with graphite metal finish.

### Modesty panel

Structural modesty panels made of 16 mm thick Structurex® panel.



Elegant and stylish worktop / leg junction

## TECHNICAL DESCRIPTION

- Worktops and legs composed of 38 mm thick Nitech® honeycomb melamine-coated panels.
- Acrylic edges with graphite metal finish and 2 mm thick shock-proof ABS edging.
- Structural modesty panels made of 16 mm thick Structurex® panel.
- Legs fitted with stabilising feet with a chrome finish.
- The desk is fitted with 2 Ø 80 mm cable ports with a square chrome cover.
- Return storage unit body (depending on version) made of 38 mm thick Nitech® melamine-coated panels. Interior fittings made of 16 mm thick Structurex® melamine-coated panels, available in 2 plain finishes (white or clay).
- As an option, the return storage unit can be fitted with :
  - A left or right reversible sliding door (L 51,2 / H 39 cm) positioned on 2 Aluminium rails. Door equipped with a lock.
  - An interior unit (L 49,6 x H 32,4 x D 51,5 cm) with 2 drawers. Drawers equipped with roller runners and a soft-close system. Top drawer equipped with a lock and inner drawer equipped with a knob. Not compatible with sliding doors.

**ELEGANCE**













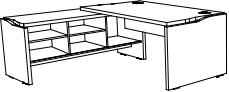

— Tops and legs  
MFC finishes

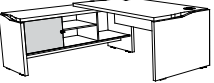

— Interior of storage  
unit finishes

Executive **DESKS**

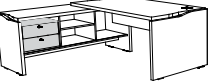
D 90 CM

	Dim. (cm)	Ref.	Finish		
<b>Straight desks</b> D 90 / H 74 cm 	L 170	DL113	+ 		
	L 190	DL123	+ 		
	Dim. (cm)	Description	Ref.	Interior of storage unit finish	Top and leg finish
<b>Straight desks on storage unit</b> D 90 to 180 / H 74 cm Storage unit D 60 / L 160 Not reversible 	L 190	Right hand return	DL13	+ 	+ 
		Left hand return	DL14	+ 	+ 
	L 210	Right hand return	DL15	+ 	+ 
		Left hand return	DL16	+ 	+ 
► Options - for storage unit					
<b>Sliding door</b> 			Description	Ref.	Finish
			Can be positioned on the right or left of the storage unit	DL173	+ 
<b>2 flat drawers *</b> * Not compatible with sliding door 			Description	Ref.	Finish
			Can be positioned on the right or left of the storage unit	DL183	+ 



# ELEGANCE





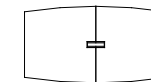

EXECUTIVE DESKS

## Conference TABLES

The conference tables are composed of multiple tops which will not have continuity of grain when placed next to each other.

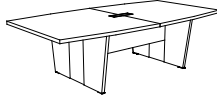

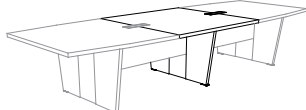

D 120 / 140 CM

	Dim. (cm)	Description	Ref.	Finish
<b>Conference table</b> 	D 120 - 140 / H 75 / L 260	Conference table (seats 8 to 10 people) with double opening Top Access hatch	DR903	+ 
<b>Central extension for conference tables</b> 	D 140 / H 75 / L 140	Central extension (seats 4 people) with double opening Top Access hatch	DR913	+ 

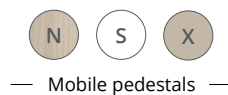
## STORAGE



	Dim. (cm)	Description	Ref.	Finish
<b>Mobile pedestals</b> 	D 59 / H 60 / L 42	2 drawers including 1 lateral filing drawer	AQ671	+ 
		3 box drawers	AP211	+ 

How to order ? Conference table L 260 cm, Bleached Oak MFC finish = DR903 + 