

□ RETRO

Retro enables companies with tight budgets to create work spaces that are both functional and stylish.

Designed using Structurex® panels, **Retro**'s clean lines are the timeless choice for robust furniture. Available in panel leg or open leg with base, the **Retro** modular programme is a complete office layout solution to produce individual or collective installations.

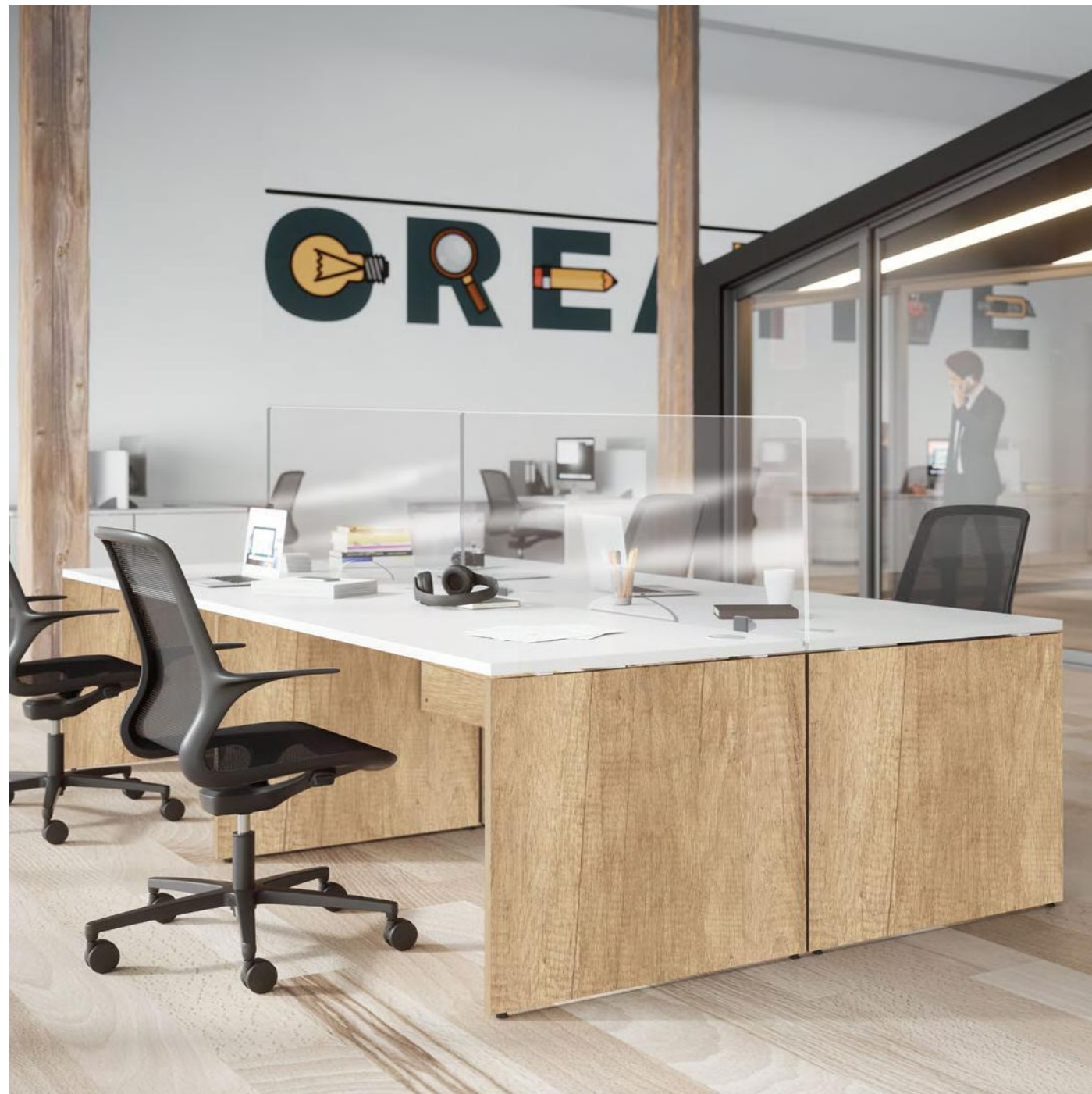



□ RETRO



CHARACTERISTICS



— Tops, legs and modesty panels MFC finishes —

RETRO



SINGLE DESKS

Top

25 mm thick Structurex® melamine-coated tops. 2 mm thick shock-proof ABS edging.

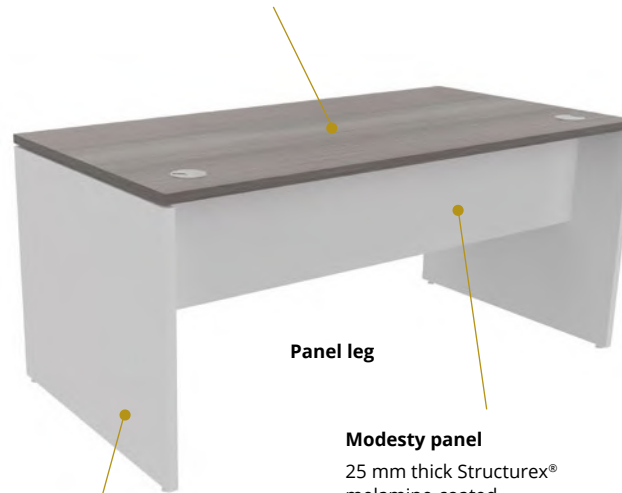

Panel leg

Modesty panel

25 mm thick Structurex® melamine-coated modesty panel.

Leg

Panel leg made of a 25 mm thick Structurex® solid panel and metal spacers.

Top

25 mm thick Structurex® melamine-coated tops. 2 mm thick shock-proof ABS edging.

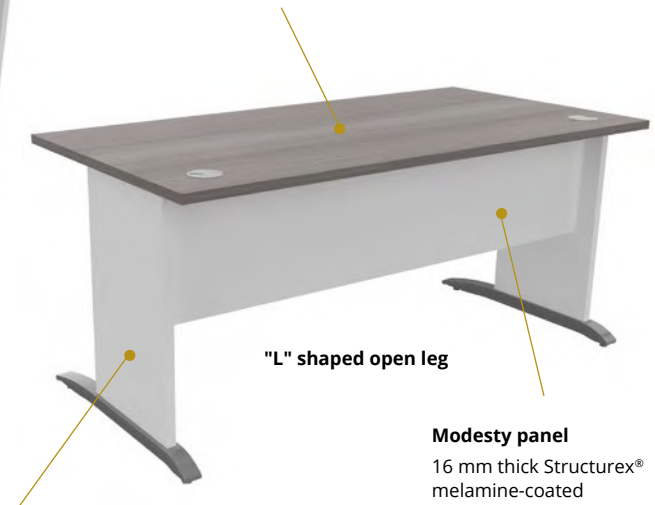

"L" shaped open leg

Modesty panel

16 mm thick Structurex® melamine-coated modesty panel.

Leg

L-shaped open leg made of a Structurex® panel on a solid wood base with lacquered aluminium finish.

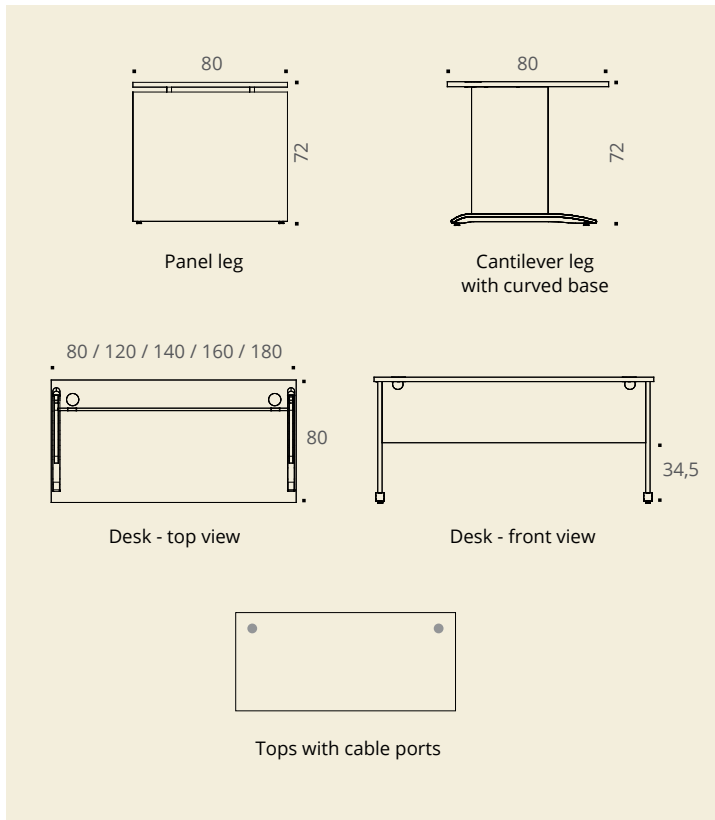

TECHNICAL DESCRIPTION

- 25 mm thick Structurex® melamine-coated tops. 2 mm thick shock-proof ABS edging.
- Tops fitted with Ø 80 mm cable ports (aluminium finish as standard, optional white or black finishes).
- Leg available in 2 versions:
 - Panel leg made of a 25 mm thick Structurex® solid panel and metal spacers (aluminium finish).
 - L-shaped open leg made of a Structurex® panel on a solid wood base with lacquered aluminium finish.
- 25 mm thick Structurex® modesty panel on panel leg desk and 16 mm thick Structurex® modesty panel on open leg desk, with 2 cutouts at the top to feed cables.
- Adjustable screw feet of Ø 25 mm and 10 mm range to compensate for any unevenness in the floor.



RETRO
WARRANTY
5 YEARS

OFFICE EXCELLENCE CERTIFIED
www.enr.com
10 DAYS
LEAD TIME



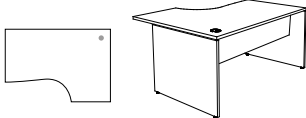

Tops, legs and modesty panels MFC finishes

DESKS with panel legs

D 80 CM

		Dim. (cm)	Ref.	Leg and modesty panel finish	Top finish	Price ex.VAT
Straight desks D 80 / H 72 cm		L 80	BT80	+ <input type="checkbox"/>	+ <input type="checkbox"/>	£ 260
		L 120	BT81	+ <input type="checkbox"/>	+ <input type="checkbox"/>	£ 290
		L 140	BT82	+ <input type="checkbox"/>	+ <input type="checkbox"/>	£ 300
		L 160	BT83	+ <input type="checkbox"/>	+ <input type="checkbox"/>	£ 310
		L 180	BT84	+ <input type="checkbox"/>	+ <input type="checkbox"/>	£ 320
90° compact desks D 80 to 110 / H 72 cm D 60 cm return		L 160 right hand return	BT87	+ <input type="checkbox"/>	+ <input type="checkbox"/>	£ 400
		L 160 left hand return	BT88	+ <input type="checkbox"/>	+ <input type="checkbox"/>	£ 400
		L 180 right hand return	BT89	+ <input type="checkbox"/>	+ <input type="checkbox"/>	£ 420
		L 180 left hand return	BT90	+ <input type="checkbox"/>	+ <input type="checkbox"/>	£ 420

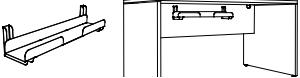
Options

	Description	 ALUMINIUM	 WHITE	 BLACK	Price ex.VAT
		Ref.	Ref.	Ref.	
Single metal cable tray 	D 13 / H 12 cm / Useful H 4 cm L 60 cm	AF051K	—	—	£ 46
Cable port covers 	Ø 80 mm - To fit into D 80 mm cable port Set of 2	AX061K	AX067S	AX065G	£ 11

Tops come with aluminium finish cable port covers

 How to order ? Straight desk D 80 / L 140 cm, **White** panel legs and modesty panel, **White** MFC finish top = BT82 + **S** **S**



Tops, legs and modesty panels MFC finishes





RETRO



SINGLE DESKS

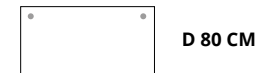

DESKS with cantilever legs and curved base

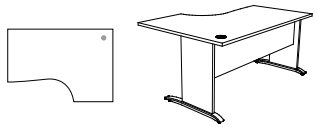

	Dim. (cm)	Ref.	Leg and modesty panel finish	Top finish	Price ex.VAT	
Straight desks D 80 / H 72 cm		L 80	AX46	+ <input type="checkbox"/>	+ <input type="checkbox"/>	£ 315
	L 120	AX47	+ <input type="checkbox"/>	+ <input type="checkbox"/>	£ 345	
	L 140	AX48	+ <input type="checkbox"/>	+ <input type="checkbox"/>	£ 355	
	L 160	AX49	+ <input type="checkbox"/>	+ <input type="checkbox"/>	£ 365	
	L 180	AX50	+ <input type="checkbox"/>	+ <input type="checkbox"/>	£ 375	
90° compact desks D 80 to 110 / H 72 cm D 60 cm return		L 160 right hand return	AX58	+ <input type="checkbox"/>	+ <input type="checkbox"/>	£ 455
	L 160 left hand return	AX59	+ <input type="checkbox"/>	+ <input type="checkbox"/>	£ 455	
	L 180 right hand return	AX60	+ <input type="checkbox"/>	+ <input type="checkbox"/>	£ 475	
	L 180 left hand return	AX61	+ <input type="checkbox"/>	+ <input type="checkbox"/>	£ 475	

A cylindrical support leg is required if the compact desk is used alone, without a supporting extension pedestal D 60 cm.

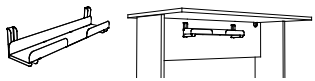
Options

Description	<input type="radio"/> ALUMINIUM <input type="radio"/> WHITE <input checked="" type="radio"/> BLACK			Price ex.VAT	
	Ref.	Ref.	Ref.		
Cylindrical support leg 	For compact desk H 72 cm	AQ001K	AQ007S	AQ005G	£ 32
Single metal cable tray 	D 13 / H 12 cm / Useful H 4 cm L 60 cm	AF051K	—	—	£ 46
Cable port covers 	Ø 80 mm - To fit into D 80 mm cable port Set of 2	AX061K	AX067S	AX065G	£ 11

Tops come with aluminium finish cable port covers

How to order ? Straight desk D 80 / L 140 cm, Beech MFC finish cantilever leg and top = AX48 + A A